

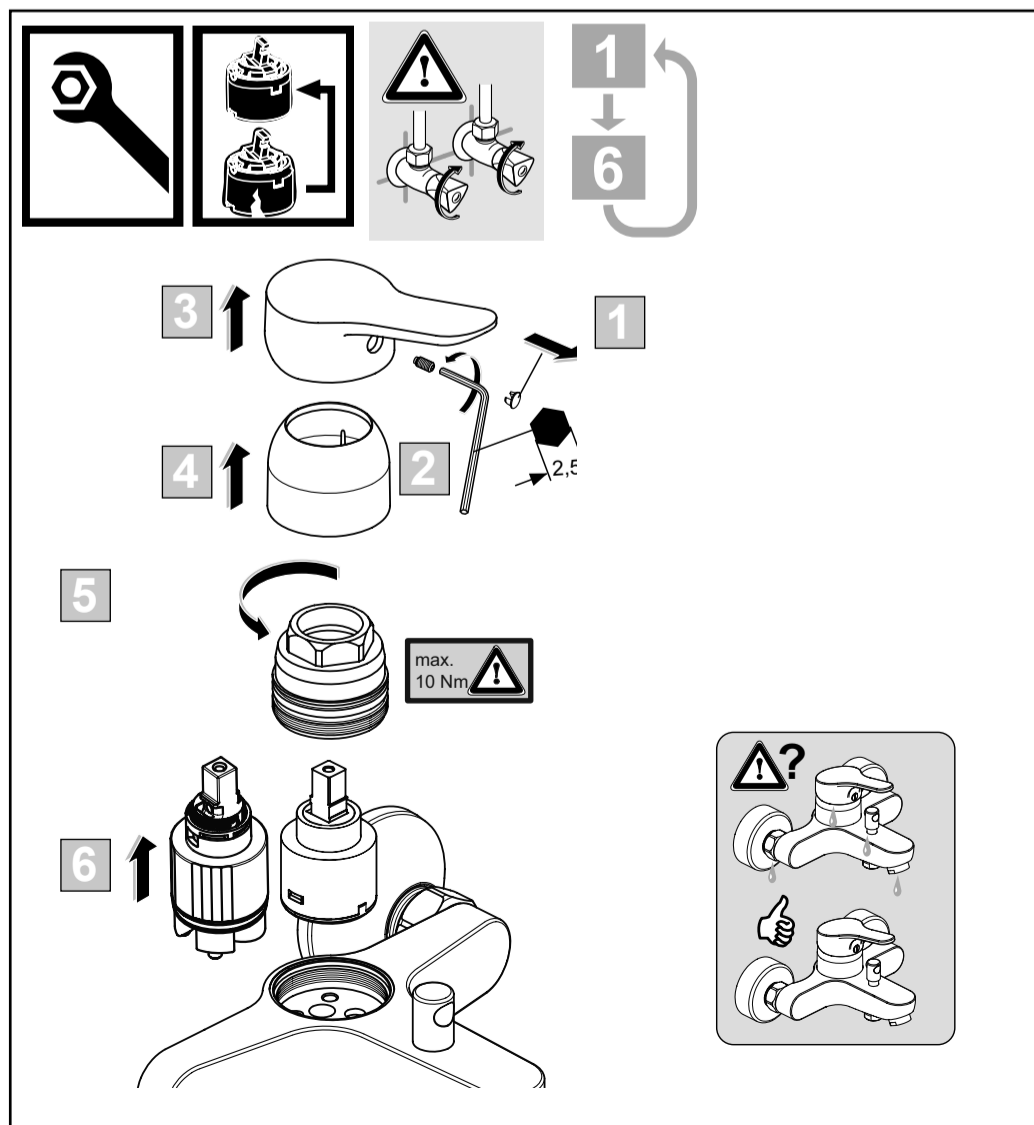

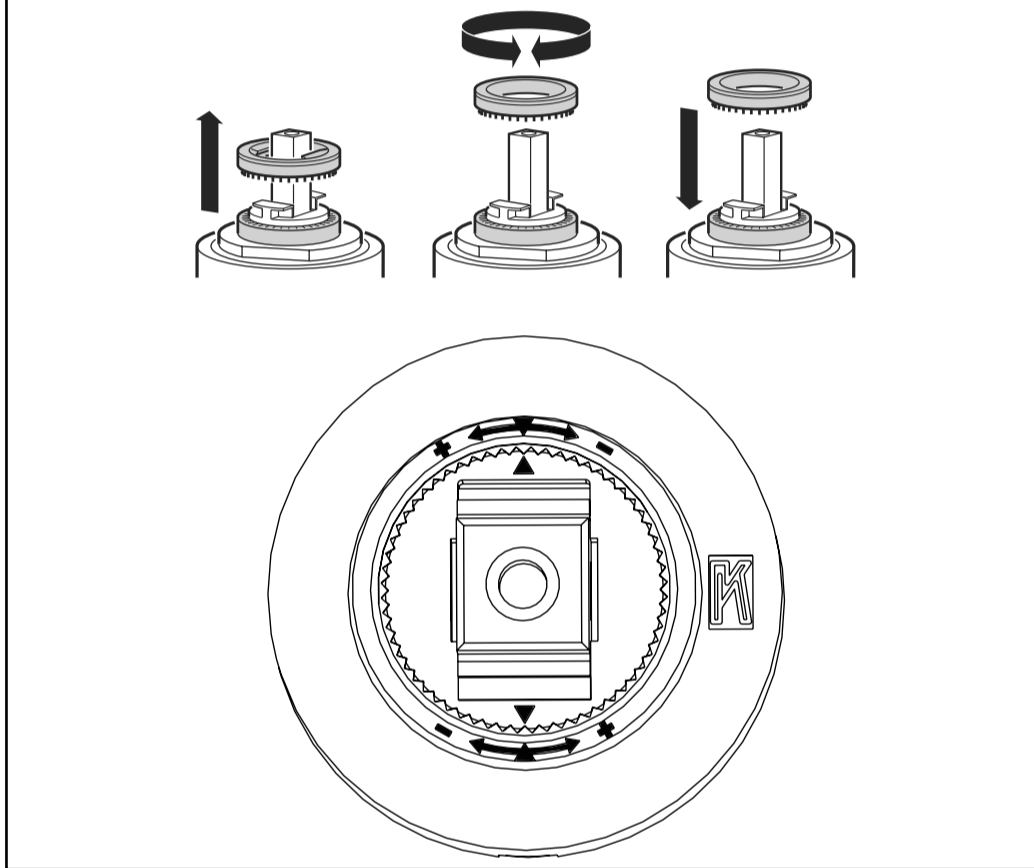







 Temperature limiter / Temperaturbegrenzer / Limiteur de tempéérature / Limitatore della temperatura / Limitador de temperatura / Temperatuur begrenzer (NL / B) / Ρυθμιστής Θερμοκρασίας / Temperaturbegrænser / Temperaturbegränsare / Temperatursperre / Ограничител на температура / Ограничитель температуры / Ogranicznik temperatury / Limitator de temperatură / Hőmérséklet korlátozó / Обмежувач температури / Ограничивач температуре / Ограничител на температура / Temperatūros ribotuvai / Temperatuuri piiraja / Temperatūras norobežotājs / Omezovalč teploty / Obmedzovač temperature



 P bar	 MAX. 10	 5		 Q (3 bar)
 T °C	 MAX. 80	 65	 40	 l/min
				20
				13